

# Oxygen Gas Sensor

(0~100% Vol oxygen gas)

Product Data Sheet  
Model #SS1118

2023. Ver 1.0

## Applications

- Ideal for portable instrument
- Industry safety (ambient air monitoring applications)
- Combustion efficiency analysis
- Gas blending, Food storage monitoring, Medical application
- Etc.



## Specifications

Performance Characteristics	
Sensor Type	Galvanic cell (lead-oxygen battery)
Measurement Range	0~100% Oxygen
Output Signal	6±1.5mV in air @ 25°C 60% RH
Accuracy	< ±1.0% Full scale @ constant temperature and pressure
T90 Response Time	<15 sec for 90% response
Output Linearity	Linear
Zero Offset Voltage	Less than 0.5mV in 100% N <sub>2</sub> @ 25°C 40% RH
Cross Interference	Less than 0.1% O <sub>2</sub> response to 0~100% CO <sub>2</sub> 0~1% NO <sub>x</sub> , CO, H <sub>2</sub> , H <sub>2</sub> S
Environmental	
Temperature Range Continuous	-10°C to +50°C
Pressure Range	700 to 1300 mbar
Operating Humidity Range	5% to 95% Rh (Non-condensing)
Life Time	
Stability	Less than 1% drift over 8 hours and more @ constant temperature and pressure
Recommended Storage Temp	0°C to 20°C
Expected Operating Life	≥ 24 months in air
Standard Warranty	18 months from date of dispatch

## Dimension

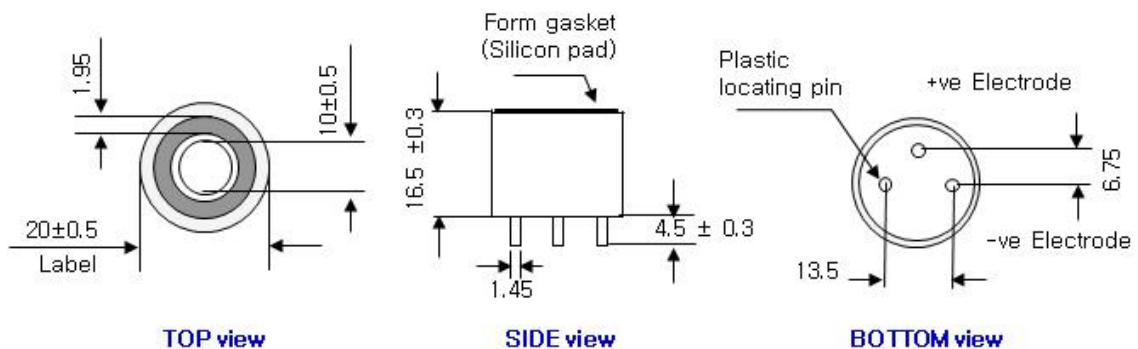

Due to ongoing research and product improvement, specifications are subject to change without notice

# Oxygen Gas Sensor

(0~100% Vol oxygen gas)

## Signal Output

The SS1118 sensor is designed to measure oxygen in the range of 0 to 100% by volume. The sensor output is linear with respect to the partial pressure of oxygen. The SS1118 sensor is compensated for the effect of temperature in the range of -10 to 40°C. Each new sensor has a unique signal output within the are defined in Figure 1. The accuracy in full scale of the SS1118 is  $\pm 1\%$  or better over the operating temperature range at constant pressure.

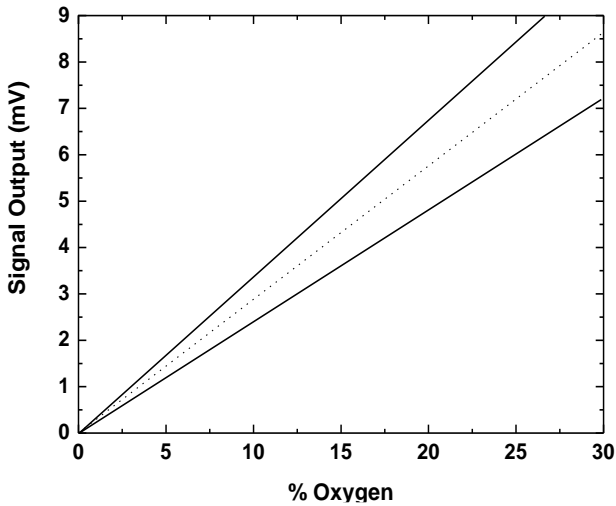

Fig 1. Signal output @ 0~30% oxygen

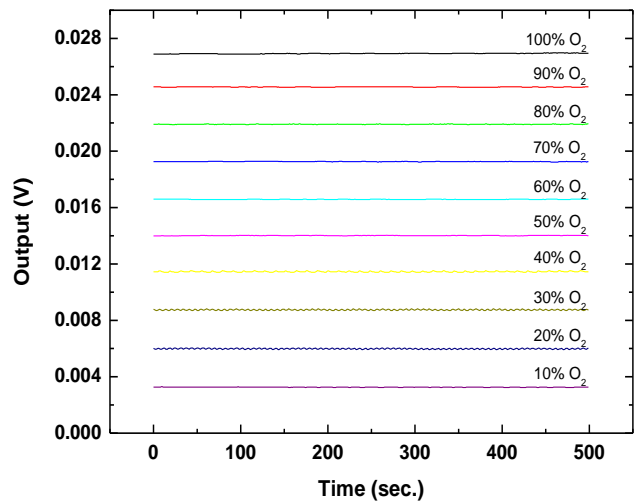

Fig 2. Typical signal output @ 0~100% oxygen

## Response Time

The SS1118 will respond to change in oxygen concentration on the order of 90% of the final value within 15 seconds or better. For example, as shown in figure 3, if the sensor is exposed to 20.9% O<sub>2</sub> (air) from a starting concentration of 100% N<sub>2</sub> the signal will abruptly increase to an equivalent of 20.9% O<sub>2</sub> oxygen in 10 seconds or less.

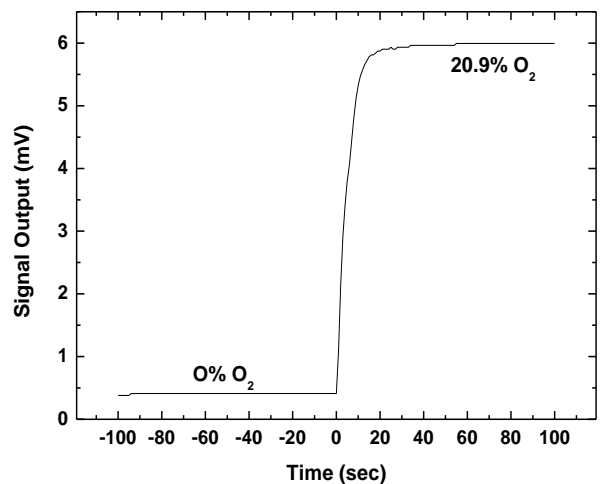

Fig 3. Response characteristics

Due to ongoing research and product improvement, specifications are subject to change without notice

# Oxygen Gas Sensor

(0~100% Vol oxygen gas)

Product Data Sheet  
Model #SS1118

2023. Ver 1.0

## Temperature and Humidity

The SS1118 sensor is designed with a temperature compensation circuit. The temperature circuit effectively compensates cell output from -10~40°C with the accuracy of 1% oxygen.

SS1118 sensor may be stored in a temperature range from -15~50°C. The signal drift during sudden temperature changes are due to the different response behavior of temperature compensation circuit built into the SS1118 and sensor itself. The drift is temporary as the sensor body itself normalizes with surrounding ambient temperature.

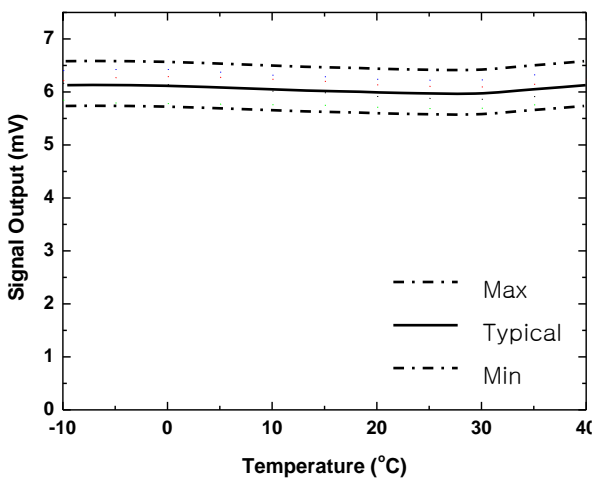

Fig 4. Temperature dependency

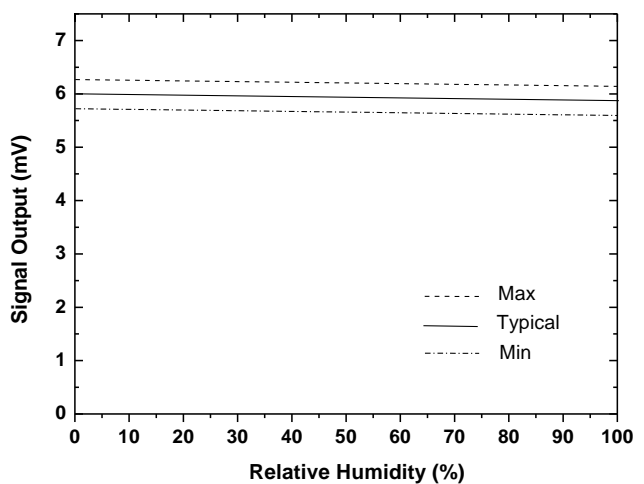

Fig 5. Humidity dependency

The signal output of SS1118 sensor is negligibly affected by the humidity change as shown in figure 5. Of course, the concentration of oxygen varies directly with change in the Relative Humidity (RH) of a sampled gas. Thus the output of a SS1118 sensor is directly proportional to changes in the RH of a sampled gas.

## pressure Effect

The SS1118 sensor measures the partial pressure of oxygen and thus are affected by changes in the sample /ambient pressures. The signal output is proportional and linear with respect to changes in the resultant partial pressure of oxygen.

The sensor output is not directly affected by sample flow. However, flow of 2 cc/minutes should be maintained to assure sample exchange at the sample position. A sample flow of 100 ~ 200 cc/minute is typical for most tests and applications.

Due to ongoing research and product improvement, specifications are subject to change without notice

# Oxygen Gas Sensor

(0~100% Vol oxygen gas)

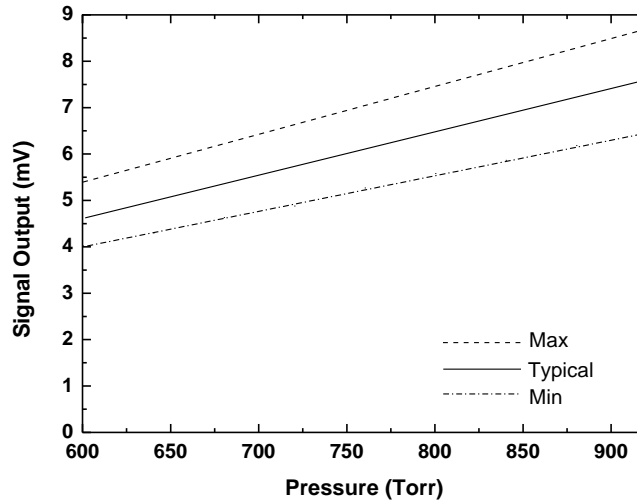
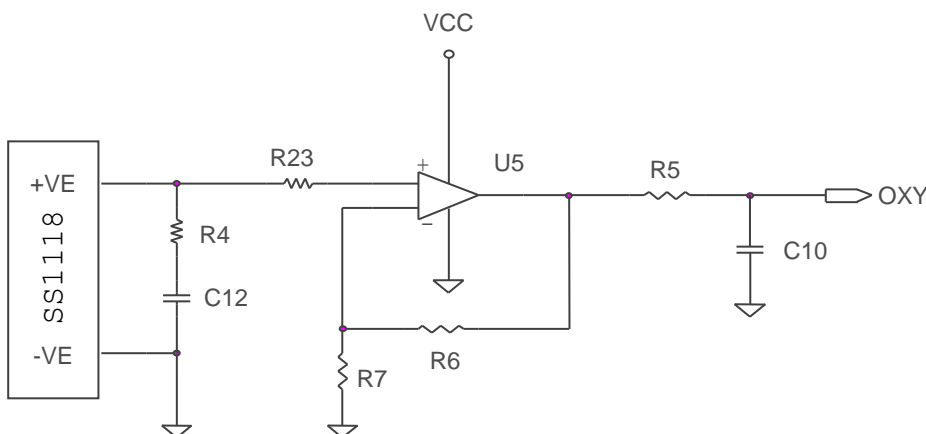

Fig 6. Pressure dependency

## Expected Life and Warranty

Because the SS1118 sensor is galvanic cells, life is calculated based on the theoretical consumption of cell components of lead anode and electrolyte. Under 20.9% O<sub>2</sub>, ambient, the life time of the SS1118 is estimated to the approximately 2 years or longer. It is important to note that several factors effect the actual lifetime of a sensor. These factors include storage temperature, operating temperature, pressure, and exposure to chemicals. The standard warranty period of SS1118 is 18 months from the date of shipment with the condition of normal operating condition.

## Basic Test Circuit



Due to ongoing research and product improvement, specifications are subject to change without notice

# Oxygen Gas Sensor

(0~100% Vol oxygen gas)

Product Data Sheet  
Model #SS1118

2023. Ver 1.0

## Guidelines

- Use only within specified conditions. Especially do not expose the sensor to gas sample streams exceeding those listed under “Operating Temperature”
- Take precautions to prevent condensations on the surface of the sensing surface
- Sensor characteristic should be measured in clean air
- Electrode pins must be correctly connected (note the outline dimension)
- Do not apply voltage directly to electrode pins
- Do not bend electrode pins
- Do not subject the sensor to excessive shock or vibration
- Do not blow organic solvent, paint, chemical agents, oils or high concentration gases directly onto sensors
- Do not solder to pins of sensor directly. Use exclusive sockets
- Do not disassemble or change any parts
- Return used sensors to SENKO Co., Ltd. Discarded sensor may cause environmental pollution, because sensors include Pb

Due to ongoing research and product improvement, specifications are subject to change without notice

SENKO.CO.Ltd, 73, Oesammi-ro 15beon-gil, Osan-si, Gyeonggi-do, 18111, South Korea  
Telephone:+82-31-492-0445 Fax:+82-31-492-0446 E-mail:sales@senko.co.kr Website:www.senko.co.kr